



**AMCON AUTOMATIC
CHART PROJECTOR
USER'S MANUAL**
EQ-6002

AMCON The Eyecare Supply
C ENTER®

1-800-255-6161 • Fax 1-800-397-0013

www.amconlabs.com



Disclaimer	3
1. Introduction	4
2. Safety Instructions	5
3. Operating Specifications	7
3.1 Conversion from “M” Notation to Snellen Notation	9
4. Names of the parts	10
4.1 Names of the parts on the projector body	10
4.2 Remote Controller	11
5. Operating Procedures	12
5.1 Preparation	12
5.2 Operation of the remote controller	13
5.3 Using the program function	14
5.4 Carrying out program base examinations	16
5.5 Using charts to measure binocular functions	17
6. Maintenance and Care	19
6.1 Daily Maintenance	19
6.2 Replacing the projection lamp (bulb)	20
6.3 Replacing the fuse	23
6.4 Changing the channel setting of the remote control. ...	24
7. Troubleshooting	25

Disclaimer

Amcon: The Eyecare Supply Center makes no representations or warranties, either expressed or implied, with respect to the contents hereof and specifically disclaims any warranties, merchantability or fitness for any particular purpose. Further, Amcon: The Eyecare Supply Center reserves the right to revise this publication and to make changes from time to time in the contents hereof without obligation of this company to notify any person of such revision or changes.

1. Introduction

Thank you for purchasing the Amcon Auto Chart Projector.

Please read these instructions and keep this manual in a convenient location for future reference.

The remote controlled Amcon Auto Chart Projector is used to test eyesight employing the principle of optical imaging. Additionally, by projecting charts on the screen and changing the shape and size of the charts, spherical power, cylinder power and accommodation balance can be tested. These same techniques can be used to determine the quality of glasses.

The Amcon Auto Chart Projector provides operational convenience in a high quality instrument.

2. Safety Instructions

To ensure safe use of this product, it is important that you follow the instructions outlined in this manual as well as the warning notices on the instrument.

- Please read this user's manual before you operate your projector. Save this user's manual for future reference.
- Do not look directly into the projector lens during operation. The intense light beam may be harmful to your eyes.
- To avoid damage, always place this device on a stable stand. This instrument is not designed to sustain rough treatment or falls.
- To reduce the risk of electric shock, do not disassemble this appliance. Take it to a qualified technician when service or repair is required. Incorrect re-assembly can cause malfunction of the projector or electric shock when the appliance is subsequently used.
- Never attempt to replace the lamp assembly or any electronic component unless the instrument is unplugged from the power source.
- Always open the lens shutter or remove the lens cap prior to turning on the projector lamp.

- Avoid placing this projector in the following environments.
 - Poorly ventilated or confined locations. Place at least 2 inches (50 cm) from walls and allow free flow of air around the projector.
 - Locations where temperatures may become excessively high, over 90°F (32°C).
 - Locations with excessive humidity, dust, or cigarette smoke.
- Do not place any objects on projector.
- Avoid placing liquids near the projector. If the projector does become wet, immediately disconnect it from the power source.

3. Operating Specifications

Category of the charts

- a) Tumbling "E" chart 0.1, 0.16, 0.2, 0.3, 0.4, 0.5, 0.6, 0.7, 0.8, 0.9, 1.0, 1.2, 1.5 and 2.0
- b) Landolt "C" chart 0.05, 0.1, 0.16, 0.2, 0.3, 0.4, 0.5, 0.6, 0.7, 0.8, 0.9, 1.0, 1.2, 1.5 and 2.0
- c) Number chart 0.1, 0.2, 0.3, 0.4, 0.5, 0.6, 0.7, 0.8, 1.0, 1.2 and 1.5
- d) Fixed astigmatic chart
- e) R and G chart
- f) Polarized chart
- g) Balance chart
- h) Polarized crosshair
- i) Children's chart
- j) Coincidence test
- k) Worth four dot test
- l) Stereo test

Refraction distance	1.5m---6m
Projection distance	1.5m---6m
Projection magnifications	30X (at 5m refraction)
Number of charts	30
Chart changeover	1 frame / 0.1 sec.
Number of masks	Open 1, Horizontal line 5, Vertical line 8 Single isolation 21, R and G 1
Mask changeover	1 frame / 0.1 sec.
Program step	Max
Projection lamp	12V 50W (Halogen lamp) Replacement bulbs are available from Amcon Product number: RQ-6200.
Electricity	AC 110V 60Hz
Power consumption	80W
Weight	13 lbs. 3 ounces (6.0 Kg)
Dimensions	11 7/8" x 9" x 9 1/2" (300mm X 230mm X240mm)

3.1 Conversion from "M" Notation to Snellen Notation

"M" Notation	Snellen in Feet	Snellen in Meters
2	20/100	6/30
1.6	20/80	6/24
1.4	20/70	6/21
1.2	20/60	6/18
1.0	20/50	6/15
0.8	20/40	6/12
0.6	20/30	6/9
0.5	20/25	6/7.5
0.4	20/20	6/6
0.2	20/10	6/3
0.1	20/5	6/1.5

4. Names of the parts

4.1 Names of the parts on the projector body

- 1) Top cover
- 2) Remote Sensor
- 3) Front panel
- 4) Lamp cover
- 5) Barrel screw
- 6) Projection window
- 7) Base
- 8) Power switch
- 9) Power socket

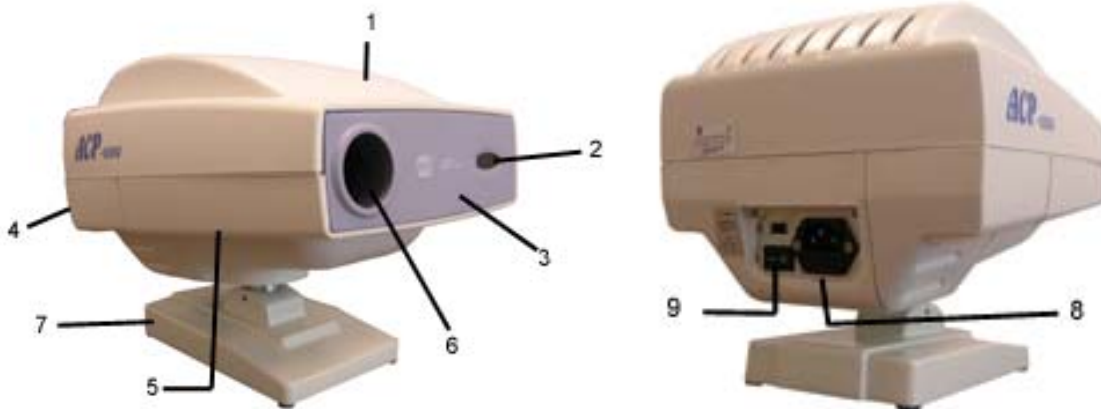



4.2 Remote Controller

The names of the parts are shown as follows.

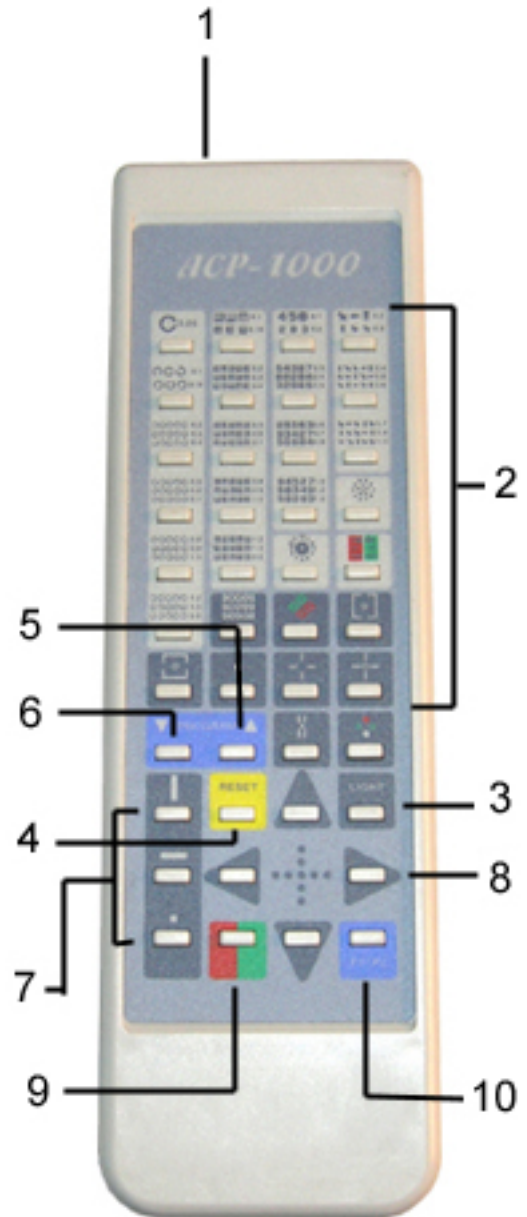
- 1) Remote Signal Emitter
- 2) Chart Switches
- 3) Light Switch
- 4) Reset Switch
- 5) Program Forward Switch
- 6) Program Back Switch
- 7) Highlight Selectors
- 8) Highlight Transfer Selectors
- 9) R/G switch
- 10) Program switch (this switch is used when activating the 'program' mode, to select P-1 or P-2)



5. Operating Procedures

	Caution: Do not tilt the projector or place in an unstable place. The projector may topple over, drop or cause injury.
	Warning: Connect the power plug to a properly grounded three-prong AC outlet. If it is connected to an ungrounded outlet, fire and/or electrical shock may result.
	Caution: Handling the power plug with wet hands can cause electric shock.

5.1 Preparation

1. Place the instrument approximately level to the person to be tested.
2. Turn the power switch 'off'.
3. Insert the power cord into the power socket on the projector body and plug into the wall outlet.
4. Turn the power switch 'on'.
5. Remove the battery cover from the back of the remote controller.
6. Insert batteries into the remote controller as illustrated and replace the battery cover.
7. Adjust the position of the projector so that the projector light is centered on the screen. Be sure the projector is in the position from which it will be used.
8. To focus the projector, slide the focusing knob that is found on the underside of the projector base. (The same side as the lamp cover.) There is a barrel screw that must be loosened before the knob can be moved. The enclosed Allen wrench can be used to loosen or tighten this screw.

5.2 Operation of the remote controller

1. Turn the projector's power switch on. The chart will automatically reset to the start position and the lamp will light.
2. When using the remote controller, point the remote signal emitter in the direction of the remote sensor on the front of the projector.
3. The switch functions are as follows
 - a) Chart Switches Projects the indicated chart on the switch.
 - b) Light Switch Turns the lamp off and on.
 - c) Reset Switch Returns to chart 1 of the program.
 - d) Program Forward Switch Forwards the program automatically.
 - e) Program Back Switch Reverses the program automatically.
 - f) Highlight Selector Isolates chart characters. (Horizontal Line of Characters, Vertical Line of Characters, Single Character).
 - g) Highlight Transfer Selectors Moves the isolation of the characters in the direction indicated.

When the highlighted area of a chart being projected advances to the maximum or minimum on that chart, the next or previous chart in the sequence will automatically appear. Charts can be switched within the same type.

- h) R&G Switch Applies the R&G filters to the designated charts.
- i) Program Switch Refer to the Program Procedure, section 5.3, for using this function.

Note: The projector will automatically turn off if not in use for 5 minutes.

5.3 Using the program function

1. How to program the Projector

1. Starting the Programming. Getting in the programming mode.

- a) Turn on the power switch. The projector goes into initialization state.
- b) Press the “RESET” button on the remote control.
- c) Press the “R and G filter” button on the remote control.
- d) Press the “Reset” button again on the remote control.

The projector will beep twice after pressing each button in “1b, 1c, 1d”. After the third button, the projector will be in programming mode.

At any time up to step “d”, pressing any other button will return the projector to normal operating state.

2. Select Program 1 or 2

Press the “P1/P2” switch to select program 1 or 2. The beeper will sound once if program 1 is selected and twice if program 2 is selected.

3. Selecting Charts for the Program

- a) Press the “program up” button to open the position for the first chart.
- b) Select the desired chart button along with the desired “highlight” button.
- c) Press the “program up” button again to enter the selection and move to open the next position of the program. The beeper will sound four times. Repeat steps 3a, 3b, 3c to enter other charts. Up to 30 selections are possible.

4. Completing the Program

- a) When finished entering, press the “Reset” button to exit.
- b) Press the light switch to turn off the projector.

5. Using the Program

- a) To use a program, select program P1 or P2 by pressing the “P1/P2” button. The beeper will indicate the program selected by sounding once for P1 and twice for P2.
- b) Press the “Program Up” button to run the program. The “Program Up” and “Program Down” buttons will advance or reverse the program.

5.4 Carrying out program base examinations

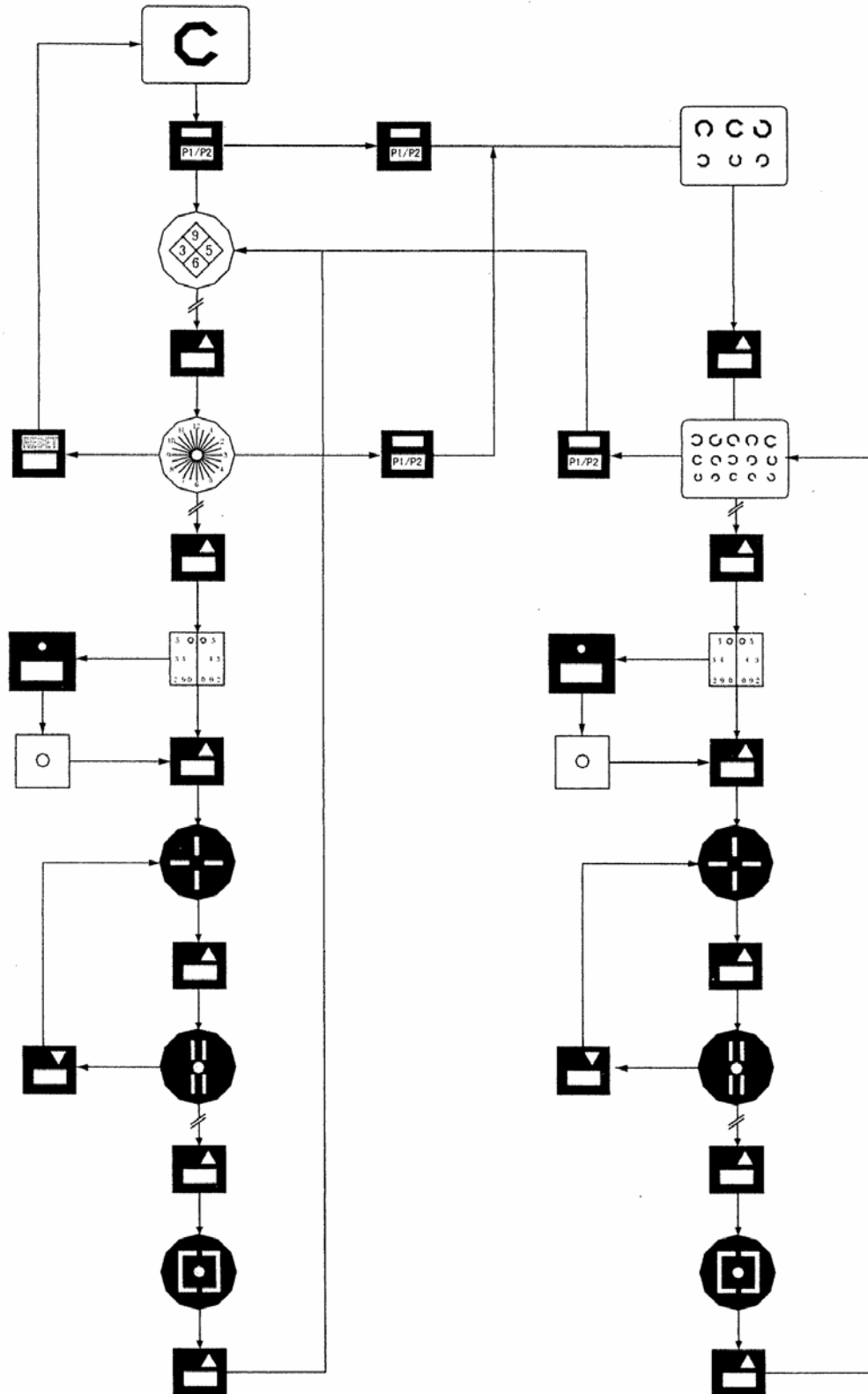

5.5 Using charts to measure binocular functions



















	Polarize R and G test	Binocular balance test	Worth four dot test	
Chart				
Filter	Polarizing filters	Polarizing filters	Red filter for the right eye and green filter for the left eye	
Purpose	Test of binocular refraction and accommodation balance.	Test of the final binocular refraction balance.	Test of the function of binocular fusion.	
Right eye				
				
How the charts are viewed.	<p>Myopia</p> <p>Right eye is over corrected and the left eye is under corrected.</p>  <p>Left eye is over corrected and the right eye is under corrected.</p> 	<p>Presbyopia</p> <p>Left eye is over corrected and the right eye is under corrected.</p>  <p>Right eye is over corrected and the left eye is under corrected.</p> 	<p>There is a variance of degree between the right eye and the left eye.</p>  <p>Adjust the spherical power to provide binocular balance.</p> 	<p>In the case where 4 dots are seen, there will be normal fusion.</p>  <p>If only two targets are seen, the left eye is suppressed.</p>  <p>If only three green targets are seen, the right eye is suppressed.</p>  <p>If five targets are seen, it indicates that the patient has diplopia.</p> 
	How the charts are seen binocularly	<p>The binocular refraction and accommodation balance are achieved when the two reds of two greens are seeing at the same intensity.</p> 		

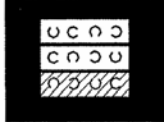
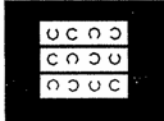

Chart		Polarized crosshair test	Reticle test with a fixation target	Coincidence test	Coincidence test	Stereo test
Filter		Polarizing Filters	Polarizing Filters	Polarizing Filters	Polarizing Filters	Polarizing Filters
Purpose		Test binocular balance and hetero-phobia.	Binocular test for fixation disparity.	Test of aniseikonia and vertical heterophobia which cannot be tested with the polarized crosshair test	Test of aniseikonia and vertical heterophobia which cannot be tested with the polarized crosshair test	Test of presence of stereoscopy.
How the charts are viewed	Right Eye					
	Left Eye					
How the charts are seen binocularly		<p>Esophoria</p> <p>Exophoria</p> <p>Left eye hyperphoria</p> <p>Left eye hypophoria</p> <p>If either line is seen thinner, the eye in question is suppressed.</p>	<p>The right eye has an infixation display.</p> <p>Indicates that the right eye has an infrafixation disparity.</p> <p>Indicates that the right eye has a vertical disparity.</p> <p>Left eye hypophoria.</p> <p>If either is clearly visible, there is suppression with the periphery of the retina in question.</p>	<p>Aniseikonia of about 7%.</p> <p>Equivalent to two lines. A single line indicates about 3.5%.</p> <p>Vertical heterophoria</p> <p>If either line is seen thinner</p> <p>The eye in question is suppressed.</p>	<p>Aniseikonia of about 7%.</p> <p>Equivalent to two lines. A single line indicates about 3.5%.</p> <p>Vertical heterophoria</p> <p>If either line is seen thinner</p> <p>The eye in question is suppressed.</p>	<p>Two lines are seen in fusion to form a single line image and floated or sunk against the central circle. If the images are slowly fused, there is still correctable heterophoria.</p>

6. Maintenance and Care

6.1 Daily Maintenance

- 1) Cover the projector when not in use. This instrument is sensitive to dust contamination.
- 2) Turn the power switch off when not in use. It is also recommended to unplug this instrument when not in use for longer periods of time.
- 3) Keep projector clean by wiping the outside panels with a dry cloth. To remove more difficult stains, a damp cloth with a mild detergent may be used. A mild glass cleaner may be used on the outside panels. Be careful not to dampen the inside parts of the projector.
- 4) When the lens is dirty, wipe it lightly with a good quality, dry micro-fiber cloth. An Amcon "Vista Cham" is recommended.

6.2 Replacing the projection lamp (bulb)

	Caution: To avoid electric shock, unplug the power cable when replacing the projection lamp.
	Caution: Do not replace the projection lamp immediately after turning off the light. The lamp may still be hot and could lead to burns.

- 1) Turn the power switch off.
- 2) Remove the lamp cover screw and remove the cover.



- 3) Remove the lamp attaching screw, hold the socket and remove the lamp.

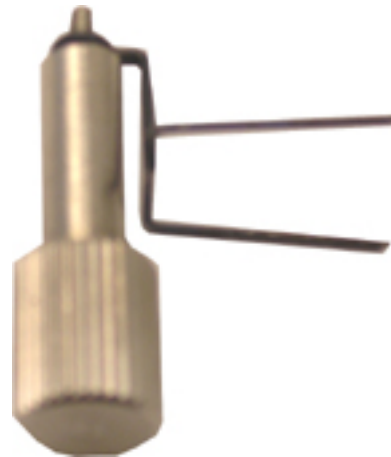

- 4) Hold the socket and the lamp flange and remove the lamp from the socket.



- 5) Install the new lamp securely. Make sure you install it in the correct direction.

Do not touch the glass of the bulb directly with your fingers. If the bulb is touched by accident, wipe the fingerprint off with alcohol.

Replacement bulbs are available from Amcon
Product number: RQ-6200.





- 6) Match the protruded part of the lamp attaching area with the lamp flange notch and tighten with the lamp attaching screw to secure the lamp.



- 7) Place the lamp cover on.
- 8) Turn the power switch on.
- 9) Make a trial projection to check that there is no illumination irregularity. If there is any irregularity, turn the power off again and check that the lamp is installed properly.

6.3 Replacing the fuse

	Warning: Unplug the power cable before removing the fuse cover to replace the fuse. Removing the fuse cover with the power cable plugged in can cause electric shock.
	Warning: Use only attaching fuses (250 v, 1 A). Using other fuses may cause a fire in the event that the instrument fails.

- 1) Turn the power switch off and disconnect the power supply plug.
- 2) The fuse holder is located just below the power supply socket. Pull on the fuse holder to remove it. The fuse will be removed together with the holder.
- 3) Remove the blown fuses and insert the new fuses on the cap of the fuse holder and install it as before.



6.4 Changing the channel setting of the remote control.

- 1) Turn the power switch off and unplug the power cable.

Remove the lamp cover screws and the screw on the lower cover (four in total) and lift the top to remove it.

Change the DIP switch 5 and 6 according to the diagram.

Remove the battery cover from the back of the remote controller and change the channel switch S.

Replace the top cover after completing the DIP switch setting, tighten the screws on the lower cover and then tighten the lamp cover with attaching screw.

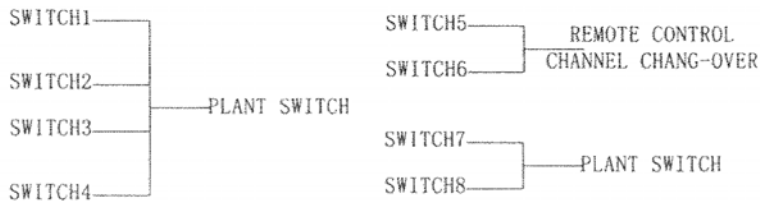
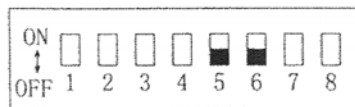

Channel	Remote control	Body	
		5	6
1	S=H	ON	OFF
2	S=L	OFF	ON

7. Troubleshooting

	Warning: Do not break down, modify or repair the equipment. Doing so can cause electric shock. Request a repair from your dealer.
---	--

Check the 'situations' covered in the following table for the problem you are experiencing. If your situation is not covered or if the recommended action does not solve the problem, contact your dealer for further support.

Situation	Question	Action
The projection lamp does not light with the power switch on.	Is the power supply cord plugged in?	Plug it securely in the outlet.
	Is the power cord connected to the projector?	Plug it securely in the power on the main body.
	Is the fuse blown?	Replace the fuse.
	Is the lamp (bulb) blown out?	Replace the lamp (bulb).
The instrument does not function when the remote controller switch is pressed.	Are the batteries dead?	Replace the batteries.
	Is there anything interrupting the light emitter on the remote control or the sensor on the projector body?	Remove the interrupting object.
	Is the remote control set at the proper channel setting?	Change the remote operating channel.